

Compact ventilation units Series SupraBox COMFORT



SupraBox ... V





BA113BB03/12/A/ SupraBox 1

Index	Page
1. General Safety Instructions	2
1.1 Warnings regarding Health and Safety	2
1.2 Safety Instructions	3
2. Technical Manual	4
2.1 General Description	4
2.2 Device overview	4
2.3 Drawings	7
3. Operating Conditions	8
4. Delivery, Transport and Storage	10
4.1 Delivery	10
4.2 Transport	10
4.3 Storage	13
5. General Installation Instruction	14
5.1 Installation of the device	14
5.2 Assembly	14
5.3 Connection of the ventilation ducts to the unit	15
5.4 Electric Installation	15
5.5 Connection of the condensate, exhaust air and overflow pipes	15
6. Initial Setup and Operation	17
6.1 General Information for the Initial Setup	17
7. Maintenance and Cleaning	18
7.1 General Maintenance Instructions	18
7.2 General Cleaning Instructions	18
7.3 Maintenance and Cleaning of the housing and the controls	19
7.4 Fans	20
7.4.1 Setup	20
7.4.2 Use	21
7.4.3 Maintenance and Cleaning	21
7.5 Reverse flow heat exchanger	22
7.5.1 Setup	22
7.5.2 Use	22
7.5.3 Maintenance and Cleaning	23
7.6 Panel filter	23
7.6.1 Setup	23
7.6.2 Use	24
7.6.3 Maintenance and Cleaning	24

1. General Safety Instructions

1.1 Warnings regarding health and safety

The following icons inform about certain hazards or safe use.

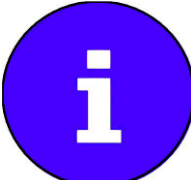
	Attention! Danger! Safety Advice!
	Hazard by electricity or high voltage!
	Crush hazard!
	Danger Overhead Hazard!
	Caution ! Hot surface
	Important Advice, Information

1.2 Safety Instruction



At the time of delivery the Rosenberg SupraBox Comfort series is constructed and produced according to the latest technical standard. Substantial tests of material, function and quality guarantee a high value and a long lifetime. When improperly used by untrained staff or not according to the instructions these machines can be dangerous.



Read these instructions carefully prior to unpacking, assembling or performing maintenance!

- The system may only be used after installation
- The following work must only be performed by trained specialists:
 - Assembly
 - Electrical Connection
 - Connection of power terminals
 - Maintenance work
- Please use the compact ventilation appliance only according to the regulations within the prescribed power limit. The power limit is included in the technical data specification or can be found on the name plates. One single instance of the prescribed power limit being exceeded will inevitably cause damage to the built-in components which results in the safe use of the appliance being compromised.
- Only approved material handling equipment may be used. Please consult your local institutions or relevant regulations for the appropriate range.
- Prior to working on electric machines these have to be disconnected from all poles (padlockable selector switches with appropriate capacity and function are included in the delivery and pre-installed).
- After completion of work at the RLT-device the responsible person must ensure that nobody is working on the installation before it is re-started.
- Authorized persons must be instructed according to the normal accident prevention regulations of the corresponding Employer's Liability Insurance Associations and be trained in their working area:
- BGV A1 „General Instructions“
 VBG 5 „Power-driven work equipment“
 VBG 9a „Load bearing equipment for hoist operations“
 BGV D27 „Industrial trucks“
 BGV A3 „Electrical systems and equipment“

2. Technical Manual

2.1 General Description

- According to the EC-Machinery Directive stationary ventilation appliances have to be electrically connected to a breaker and series fuse. It must be possible to disconnect the unit from all poles!
- The unit corresponds to the requirements of VDI 6022 as well as DIN 1946 T6.
- Depending on the size of the installation the range of application extends to a power volume of 2000 m³/h with a flow medium density of 1,3kg/m³.
- The application area includes the air treatments: filtration, heating, cooling and moving. In addition a heat recovery with high efficiency is used.
- Energy efficient compact ventilation unit – heat recovery through an aluminium reverse flow recuperator with very high efficiency. It can be dismantled for cleaning and condensate will be dissipated in a condensate pan with gradient all around.
- Unit is installed on a base frame with four adjustable feet, for balancing uneven bottoms, as well as for the outside installation. Adjustment range: 45 – 70 mm.
- The compact housing consists of corrosion-resistant, double skin, coil coated, galvanised sheet steel. Quality: DX51D + zinc 275 + additional org. coating min. 25 µm RAL 7035; metal gauge 1.00 mm.
- Side wall panels, housing bottom, housing cover, rear panel and doors (with double-skin) are equipped inside with 60 mm acoustic and heat insulation (min. 33 kg/m³; λ = 0,04 W/m x K).
- The direct drive fans with backward curved centrifugal impellers are installed in the unit with vibration absorption. The drive will be effected by energy-saving and 100% infinitely variable EC motors.
- Filtration of external air F7 and exit air M5 through particulate panel filters.
- The ventilation unit will be delivered with integrated control. This is easy to maintain and installed behind the big maintenance door (at the left) .It is completely wired and tested by the manufacturer.
- The unit is clearly labelled with symbols and text for easy operation. An external controller for managing the whole system is included.

2.2 Device Overview

SupraBox Comfort	800V	1100V	1500V	2000V
Housing	Double-skin 60 mm frameless	Double-skin 60 mm frameless	Double-skin 60 mm frameless	Double-skin 60 mm frameless
Size (L x W x H) [mm]	1470 x 600 x 1202 Incl. unions and adjustable feet	1740 x 630 x 1282 Incl. unions and adjustable feet	1980 x 710 x 1422 Incl. unions and adjustable feet	2220 x 770 x 1567 Incl. unions and adjustable feet
Operating Point	800 m ³ /h at 150 Pa	1100 m ³ /h at 200 Pa	1500 m ³ /h at 200 Pa	2000 m ³ /h at 250 Pa
Fans	Backward curved, free running, driven by highly-efficient – EC-external-rotor motors with integrated electronics			
Power Input in the operating point	2 x 225 W	2 x 320 W	2 x 475 W	2 x 780 W
SFP-Value in the operating point	1013 Ws/m ³	1047 Ws/m ³	1140 Ws/m ³	1404 Ws/m ³
SFP class in the operating point	SFP2	SFP2	SFP3	SFP3
Heat recovery Efficiency	Reverse flow- plate heat exchanger up to $\eta=92\%^*$, corresponding to WRG-classes H1 *Maximum value on condensation; heat recovery dependant on the operating condition			
Air filter	Panel filter with plastic frames		Incoming air: F7	Extracted air: M5
	328 x 478 x 96 [mm]	398 x 508 x 96 [mm]	468 x 548 x 96 [mm]	538 x 608 x 96 [mm]
Air supplies	vertical DN 250	vertical DN 315	vertical DN 355	vertical DN 400
Max. total current consumption	3 A	3,7 A	5,6 A	9,5 A
Overall sound power level				
Suction side L _{WA5}	52 dB(A)	52 dB(A)	55 dB(A)	56 dB(A)
Pressure side L _{WA6}	72 dB(A)	76 dB(A)	77 dB(A)	80 dB(A)
Housing L _{WA2}	49 dB(A)	54 dB(A)	52 dB(A)	56 dB(A)
Weight incl.Control	209 kg	253 kg	315 kg	430 kg

*Temperature control with control of optional accessories dependant on unit size and equipment

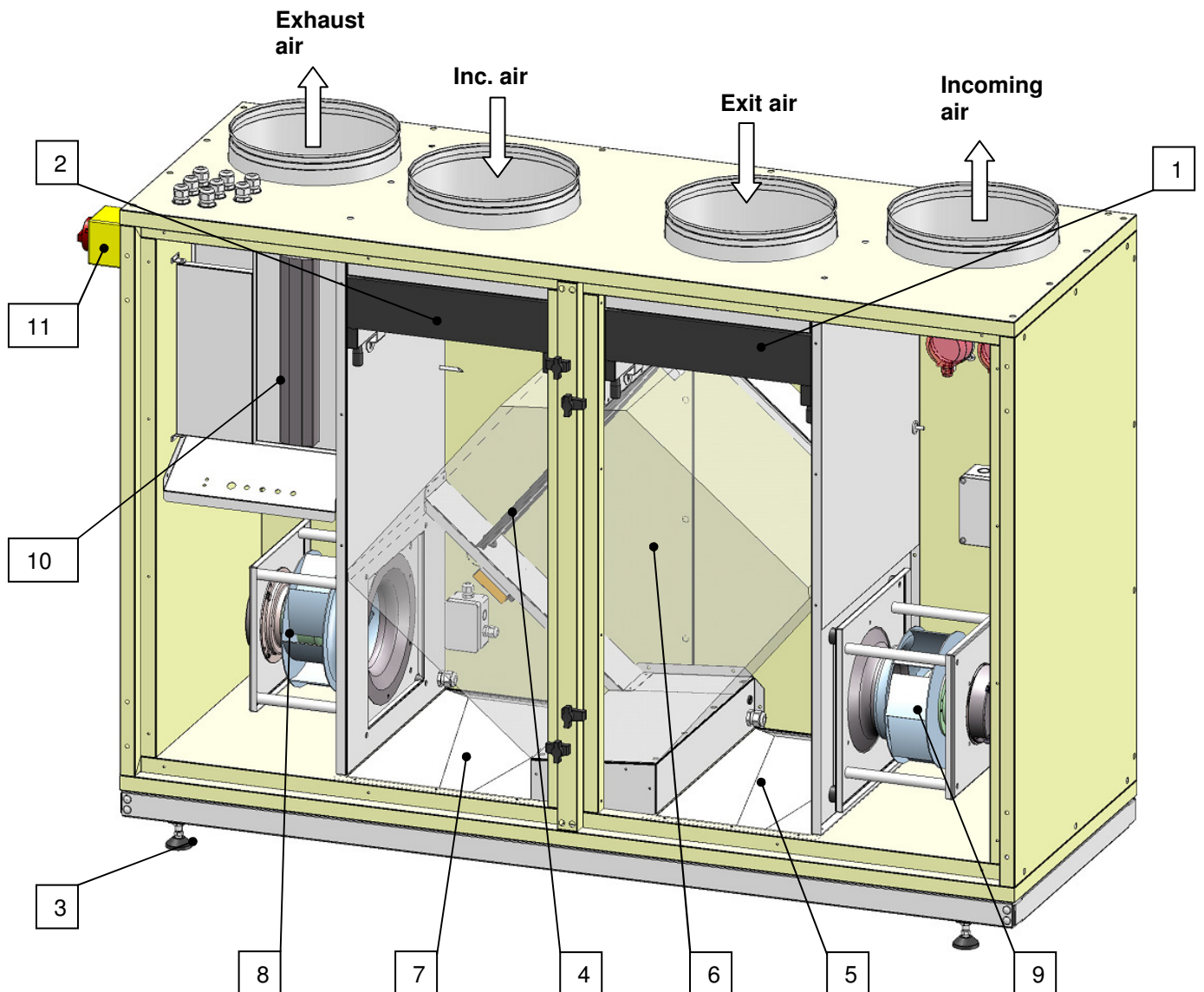

Picture: device drawing

- | | |
|---------------------------------------|------------------------------------|
| 1 Panel filter exhaust air M5 | 7 Condensate pan |
| 2 Panel filter incoming air F7 | 8 Exhaust air with EC-Motor |
| 3 Adjustable rounded base | 9 Supply fan with EC-Motor |
| 4 Bypass flap | 10 Control box |
| 5 Maintenance pan | 11 Main breaker |
| 6 Reverse flow heat exchanger | |

2.3 Device drawings

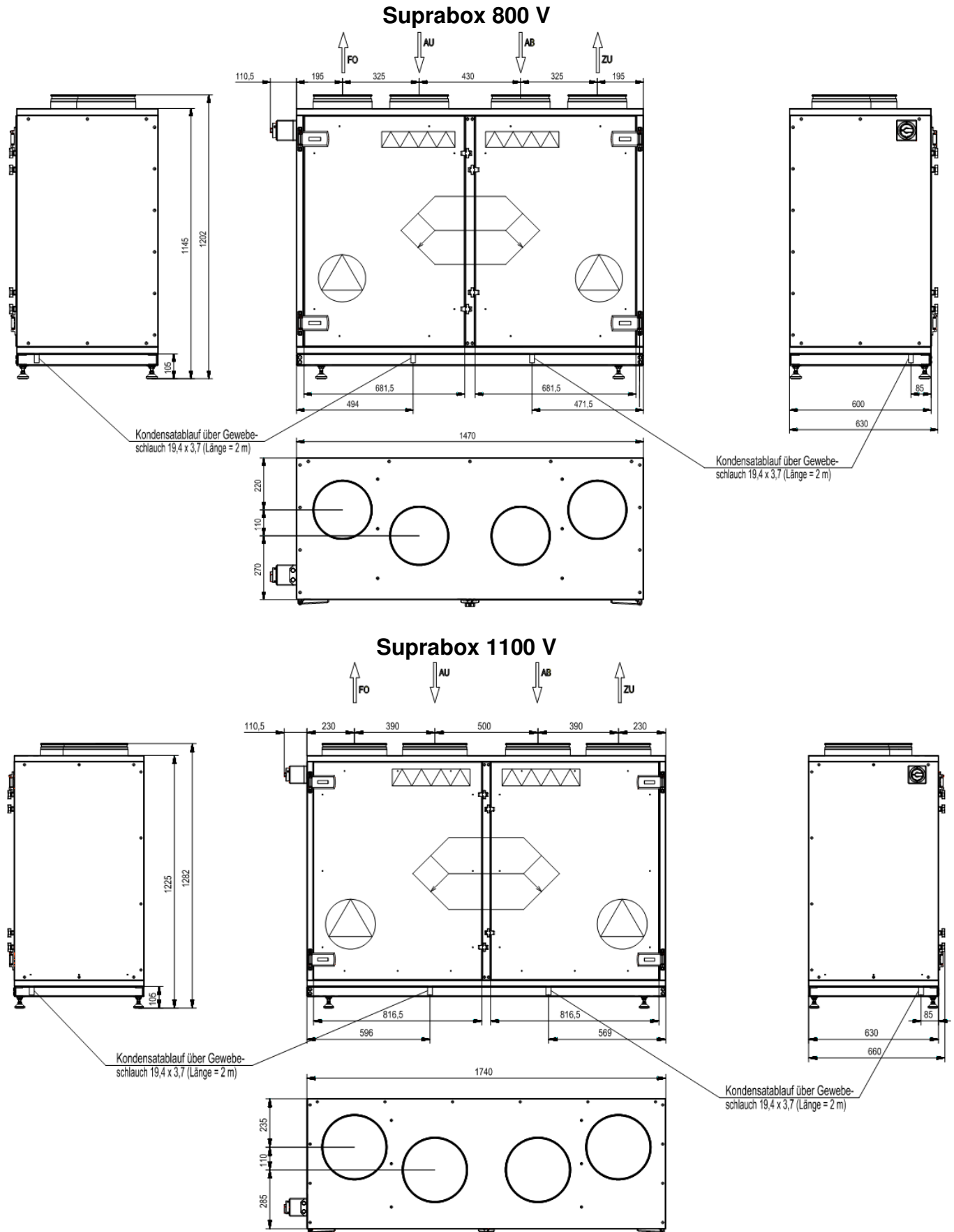

Operation and Maintenance Manual for Rosenberg Compact Ventilation appliance series SupraBox Comfort



Suprabox 1500 V

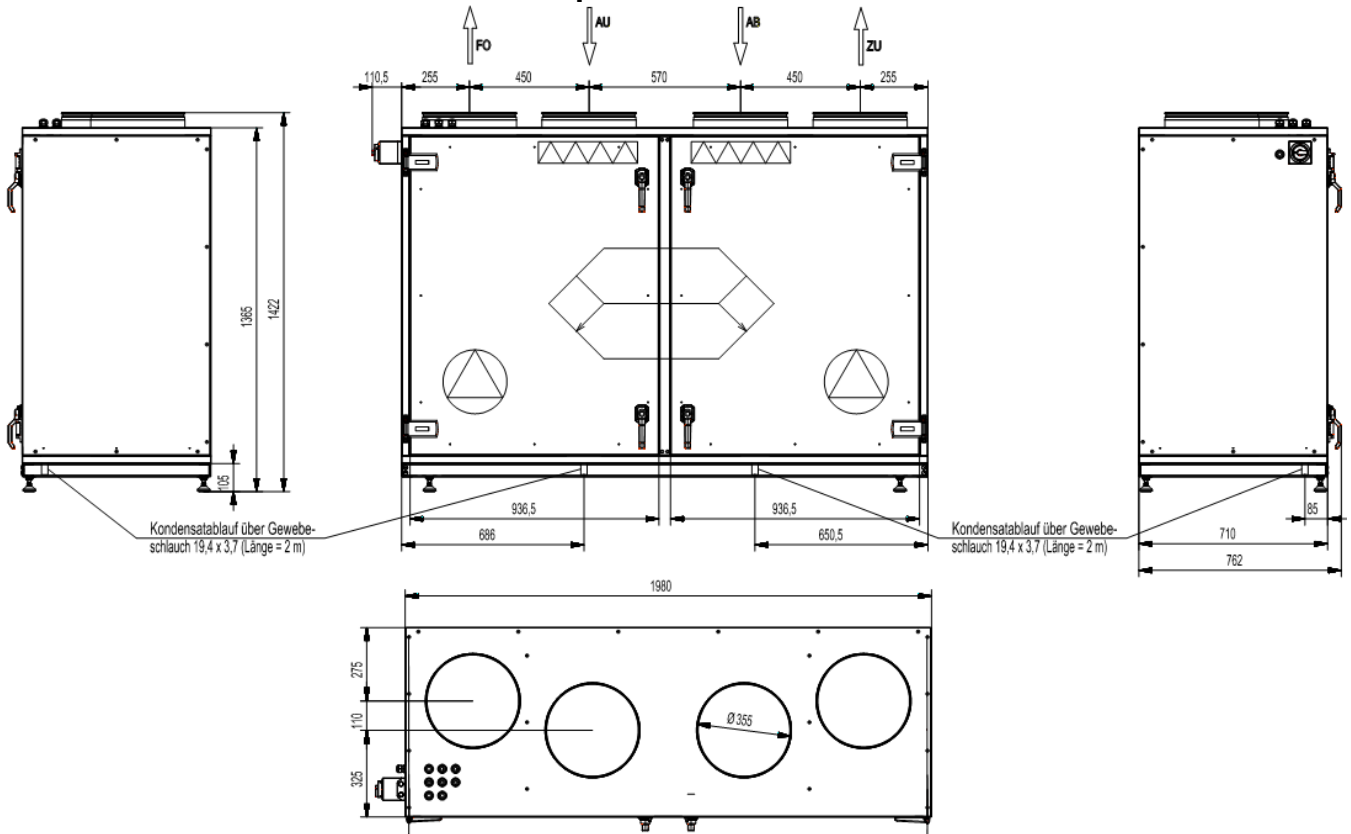

Suprabox 2000 V

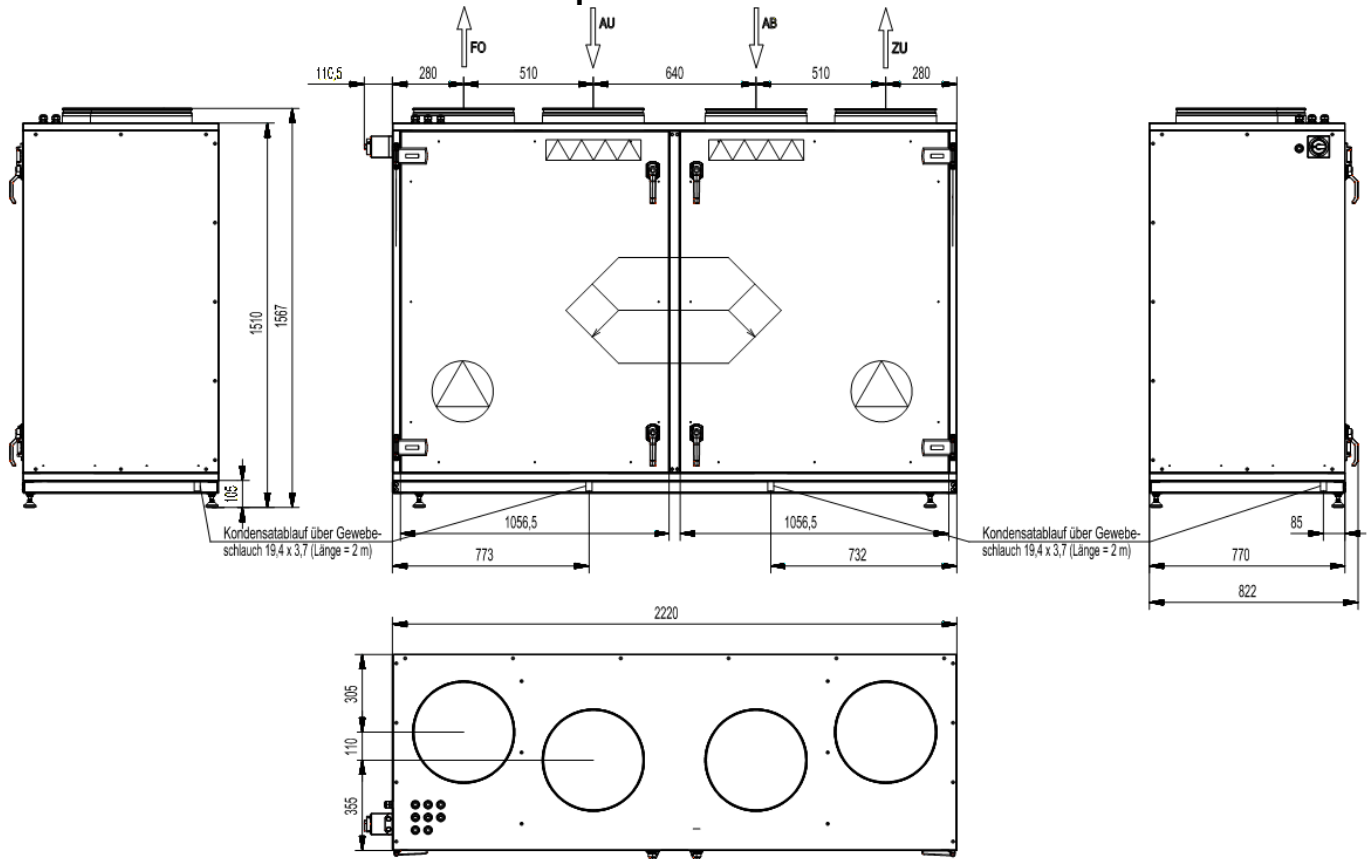

3. Operating conditions

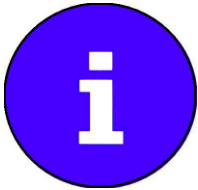

The Rosenberg compact appliance series SupraBox Comfort is exclusively made for treating air or gaseous media to the criteria below!

The compact ventilation appliance is suitable for the conveyance of:

- Clean air, low dust or low greasy air
- Slightly aggressive gases or fumes (consult the factory in either case!)
- Gaseous media up to a density of 1,3kg/m³
- Gaseous media up to a relative humidity of max. 95%
- Gaseous media in a temperature range of –16°C up to +40°C. (higher or lower ranges require special modifications!)
- Non-explosive gaseous media

4. Delivery, Transport and Storage

4.1 Delivery

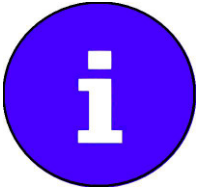

Rosenberg-Supraboxes must be checked for damages immediately on delivery. This should be made before unloading the device from the transport vehicle. Furthermore the completeness of the scope of delivery must be checked in accordance with the freight documents. Missing parts or damages must be noted on the freight documents and signed by the driver of the transport vehicle.

4.2 Transport

The unit will be delivered on a customized single use pallet and can be moved with a forklift or a pallet truck. The transport dimensions (incl. control box) and weights can be found on the drawing below:

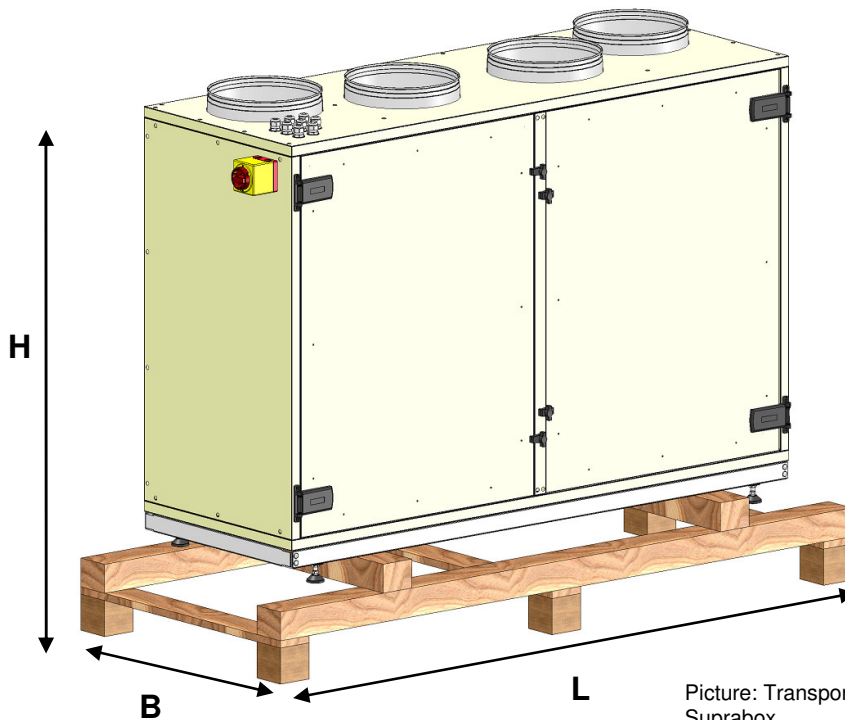

Picture: Transport Dimensions
Suprabox

Suprabox	L	W	H	Weight
800 V	1700 mm	750 mm	1427 mm	238 kg
1100 V	2000 mm	850 mm	1505 mm	287 kg
1500 V	2400 mm	850 mm	1645 mm	355 kg
2000 V	2400 mm	850 mm	1790 mm	470 kg



Avoid twisting, bending or physical damages of the housing when hoisting the device!

- Keep the control doors closed during the transport!
- Always use proper hoisting machines for the transport!
- Please note that excessive loads on the housing may cause damages!
- For your own safety use appropriate anti-slip gloves and safety shoes for the transport.

For the **transport with forklift or pallet truck** please note the following instructions:

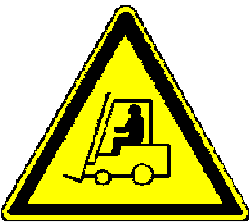

- The transport with industrial trucks requires regular training of the responsible staff according to the accident prevention regulation (in Germany BGV D27 „Flurförderfahrzeuge“).
- The loading capacity of the material handling equipment must always be checked before loading!
- The fork length of the material handling equipment must be greater than the length of the transport pallet to be picked up. Forks which are too short cause damage to the floor panels or the device frame.

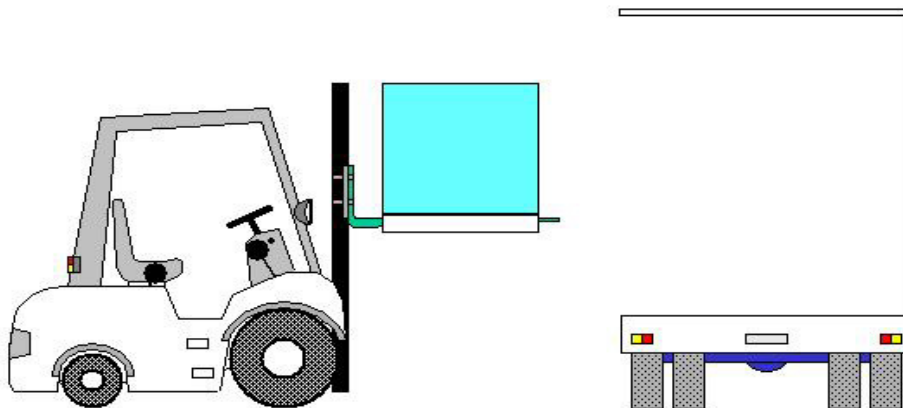

Picture Unloading by forklift

For the **transport with a hall crane or a truck crane** please note the following instructions:

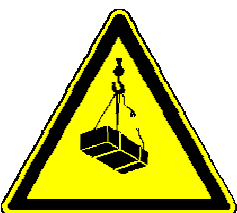

- The transport with cranes or lifting fixation devices requires regular training of the responsible person according to the accident prevention regulation (in Germany VBG 9a „Lastaufnahmeeinrichtungen im Hebezeugbetrieb“)
- Danger Overhead hazard! It is forbidden to stay below floating loads!

- For direct load attachment (underdragging the load) only use exclusively licensed, undamaged fabric slings with sufficient contact surface and edge protection. (e.g.: webbing slings according to EN1492-1 or round slings according to EN1492-2)
- It is forbidden to use chain slings or slinging ropes for the direct load attachment!
- The slings should not have an inclination angle of more than 60°!

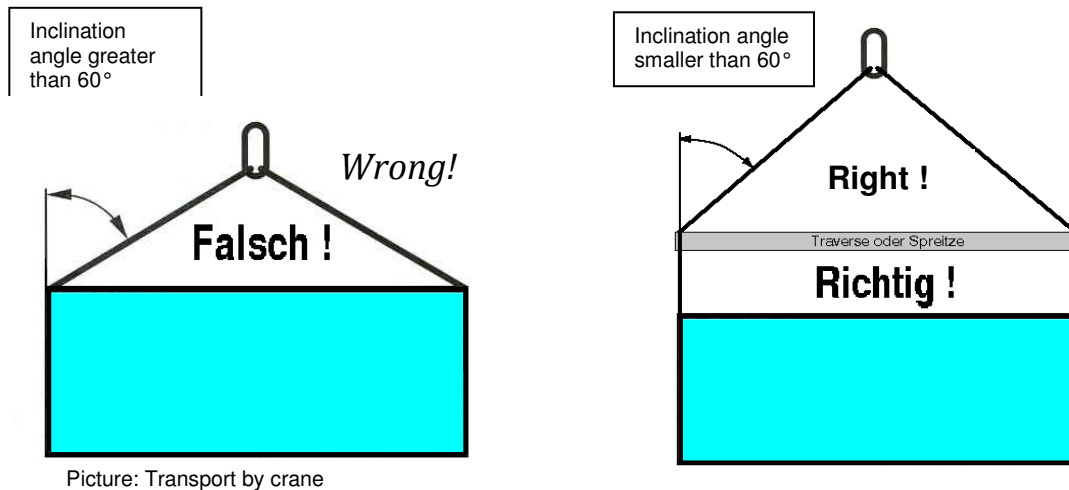

Picture: Transport by crane

- Please note that when lifting the functional part the distribution is usually out of balance! This is not visible outside of the functional part.

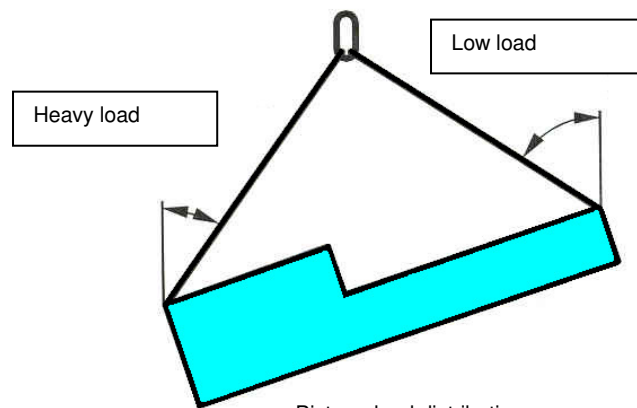

Picture: load distribution

- Only use carrying devices with the same length.
- Make careful and none jolting movements.
- Avoid setting the load down hard and bumping

4.3 Storage

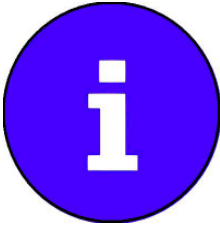

- Make sure to store the unit in a dry and weather protected area!
 - On receipt of the merchandise the packaging, film and tape must immediately be removed in order to avoid condensation water!
 - Open pallets must be covered by tarps. Protect the functional parts against pollution (e.g. chips, stones, wires etc.).
-
- Also the weatherproof functional parts must be covered, as the weather resistance can only be guaranteed after the installation.
 - Keep the storage temperature between -20 °C und +40 °C, avoid high humidity.
 - If storing the unit for more than 12 months make sure the fan turns freely before installation.



▶ **Manual rotation of the fan**

5. General Assembly Instructions

5.1 Installation of the unit

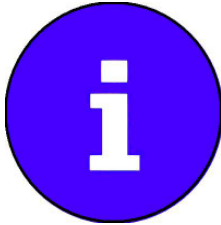

The Rosenberg-SupraBox Comfort must exclusively be installed on an foundation or appropriate substructure which is professionally constructed for this specific use.

Assumption of static or dynamic building functions by Rosenberg-devices must be excluded. Otherwise the warranty by Rosenberg Ventilatoren GmbH will expire for damages to the device or resulting damages to the building.

Installation and assembly may only be made by trained staff, familiar with the specific accident prevention regulations and general safety-related and occupational health laws.

In addition to the structural requirements consider the following instructions for the construction of the foundation or substructure:

- The installation area must be plain and non-twisted.
- The horizontal inclination angle of the installation area may not exceed a max. of 2% .

Choose an installation space with an unobstructed condensate drain and water trap, as well as a sufficient gradient of the condensate line.

- The height level between installation space and bottom must guarantee a professional condensate drain from the functional parts.
▶ **Consider the height of the waste trap!**

Even out slight space unevenness by assembled rounded bases.

In order to ensure a low noise operation consider the following advice:

- Low air velocity in the duct
- Do not install the device on a wooden ground
- Use a vibration resistant substructure

5.2 Assembly

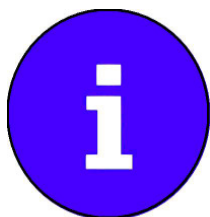

Get an overview of the quantity and identification of all functional parts with help of the enclosed technical documents. Under item 2.2 device overview or item 2.3 device drawings there is a detailed drawing with all relevant dimensions.

For an installation of the SupraBox there must be sufficient distance between the operator side and the space limit for maintenance and revision. Permanent access must be guaranteed.

The compact air conditioning units are completely plug-in wired and checked by the manufacturer. They are equipped with an integrated control.

Only the ventilation ducts, condensate and water connections must be properly installed by the customer. Furthermore the electrical supply as well as external sensors or optional accessories such as duct heaters etc. must be connected.

The remote operator control must be connected to the control using the provided cable and placed at any place at the ventilation unit or nearby. The electric connection must be made according to the wiring diagram, see separate manual control

5.3 Connection of the ventilation ducts to the unit

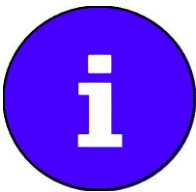

The connection sleeves of the Rosenberg-SupraBox Comfort are provided as circular tube spigots, with T-sealing lip as shown in the unit drawings. The duct system must be installed according to the valid technical standards and regulations and must support the dead load by installations of the customer. Additional requirements concerning sound insulation can be met by separate vibration isolation with elastic connections. These are usually not included in delivery, but can be provided as additional equipment. The fresh air and exhaust air duct must be isolated against condensate water.

5.4 Electric Installation

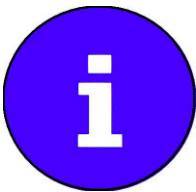

The electric connection must exclusively be made by a licensed electrician according to the VDE-regulations. The connection must be made exactly according to the wire diagram and the face plan

Check all screw joints before startup of the unit and if necessary retighten them.

Further installation information can be found in the separate operating manual of the control system.



5.5 Connection of the condensate, exhaust air and overflow pipes

The Suprabox is equipped with a maintenance and condensate pan. As shown in the device overview, the maintenance pan is placed in the incoming air duct and the condensate pan in the exhaust air duct. Both pans have a flexible tube at the bottom side of the device with an internal diameter of 19.4 mm. Do never dismantle them and check their correct fitting before the unit is installed.

The exhaust air drain of the maintenance pan is only used for cleaning. Therefore it is necessary to seal the tube of the maintenance pan with proper material (e.g. tape) in order to avoid air leakage in this area.

Especially in the cold seasons there could be condensate in the exhaust air duct of the reverse heat exchanger. In order to make sure the condensate drains correctly via the condensate pan and to avoid leakage air, it is important to attach a vacuum shown in the drawing below. Alternatively a hose can be fixed at the unit to replace a trap. The minimum sizes must be observed by the customer. Fill the trap with water before startup. Protect the trap against desiccation and in cold areas against frost.

Do not connect the spout to the sewage system. Alternatively a vacuum trap with non-return ball can be used, but make sure that there is a suction lift of at least 70 mm.

Devuce connectionb

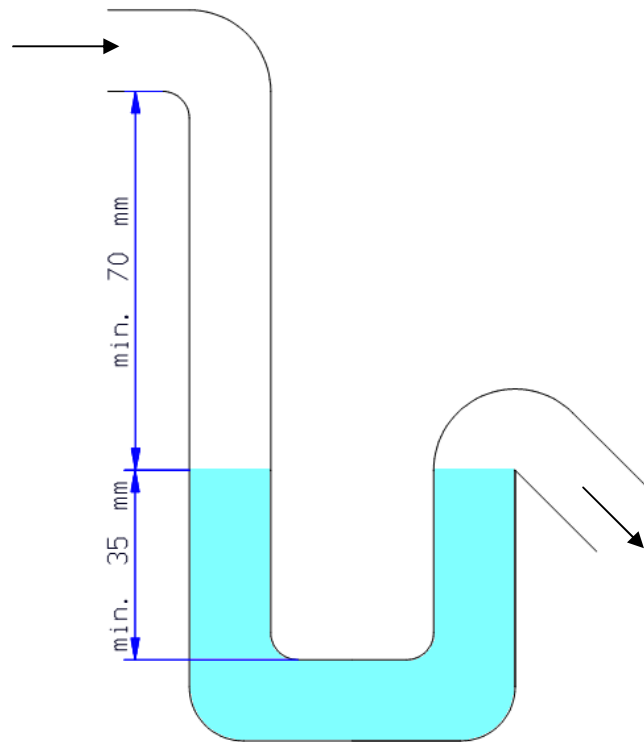

Picture: minimum size trap

6. Initial Setup and Operation

6.1 General Information for the Setup

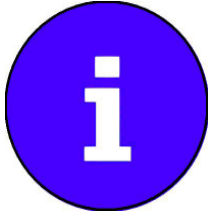

Prior to the startup of the compact ventilation unit observe the instructions below:

- Inspection of the proper installation, connection and assembly
- Free air connection, free suction holes
- Free running of the fan wheels
- Closed valves at the heat exchanger units
- Check the screw joints of all connections
- Unlock the electric duct heater only after the fan
- Remove a possible protective film
- Optical inspection of the unit gaskets for damage
- Re-adjust the hinges of the maintenance doors
- Close all doors
- Operational check of the fans

Pressure control of the reverse flow heat exchanger must be set according to the operating point of the unit



► **ATTENTION:** If the above instructions are not followed, dangerous conditions may occur on startup of the unit, which affect the functionality and safety of the unit.



► **ATTENTION:** Before stopping the unit de-energize it and remove water of optional heaters to avoid freezing

Further information for the startup of the units can be found in the corresponding component specification beginning with 7.4. The instruction manual of the control system must absolutely be observed!

7. Maintenance and Cleaning

7.1 General Maintenance Instructions



The maintenance interval indicated in this manual basically refers to the transport of normal polluted air. If the unit must transport strongly polluted air the maintenance intervals must be reduced accordingly.

► Before any maintenance work is started the unit must be stopped properly and all poles disconnected from the mains.
Proceed in the following order:



1. Stop the unit with using the remote operator. Activated full automatic weekly programs have to be deactivated first.

2. Wait 2 minutes until the optional louvered damper is closed and the fans have stopped



3. Now turn the operating switch to ZERO (Off) and make sure that it will not be switched on unintentionally. This step disconnects the compact unit from the mains with all poles. Be aware that the control box will still be hot. For maintenance at the control box the connection must be interrupted.

4.



Wait for the residual voltage to decrease at the EC-control as indicated in the instruction manual of those components.

5.

Let the heater cool down.

6. Now you can open the maintenance doors.

Pay attention that at optionally used channel-type heat exchangers the water circulation is be protected against re-starting.

7.2 General Cleaning Instructions

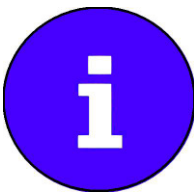

Recommended cleaning agents for surface disinfection are:

- Dismozon pur (Bode Chemie)
- Melsitt (B.Braun)
- Antifect (Schülke & Mayr)
- Clorina (Lysoform)

All disinfectants are recognized and licensed by Robert-Koch-Institute (date 31.05.2007, 15. edition)

To ensure the hygienically perfect condition of the unit the following instructions must be observed:

- Only qualified and trained staff should clean the unit (in Germany according to VDI 6022).

- The hygiene inspection at the unit has to be made according to the following intervals:
 - after startup
 - every 3 years (devices without moisturization)
- The periodical hygiene inspection is necessary to reveal hygiene deficiencies at an early stage and to rectify them with appropriate action.
- The results of the inspection of the hygienic condition, the cleaning and disinfection have to be documented in the appropriate way (e.g. operations diary).
- The relevant regulation for the hygienic requirements of the RLT-units is VDI 6022. It is the guideline for the current instructions. All work has to be carried out according to the latest version of the VDI guideline.

Please find instructions for the cleaning and hygiene inspection of each functional part of the device below.

7.3 Maintenance and Cleaning of the housing and control

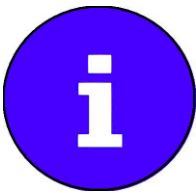

Please keep to the following instructions for the regular maintenance work (quarterly intervals):

- Check the seals of the operation doors and replace them if necessary
- Check the function of the double guide at the fan (discharge side)
- Check the panels for damages and corrosion
- Flexible parts, such as hinges, should be treated with an appropriate lubricant spray
- Remove severe loose dirt with a vacuum cleaner
- Remove other dirt with a moist cloth
- The water or cleaning agent should have a neutral ph-value (6-8)

Maintenance of the control and terminal boxes (only by an electrician)	Every 3 months	If necessary	Hygiene inspection
Check the electrical equipment, cables and connections for dirt and apparent damages and replace them if necessary	X		
Dry cleaning of the control, do not use water		X	

7.4 Fans

7.4.1 Setup



- Before connecting the unit to the mains the initial operation should be made according to the VDE regulation

- Make sure that the operating switch is set to ZERO (OFF) and protected from restarting before you open the fan enclosure.

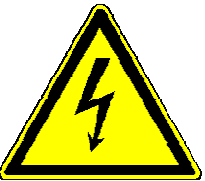

- The fans should be operated exclusively while installed, only after correct installation of the protection unit (suction protection) and with closed doors.

Before the startup of the fans check the heat recovery, the heater and the corresponding frost protection if the outside temperature is less than 5 °C and operate them if necessary in order to prevent the unit from frost damage.

- Check the unit for forgotten tools, foreign materials and dirt and clean it if necessary.
- Check all clamping elements of the fan to ensure that they are properly fixed:

- Motor and fan bearing
- Fan wheel
- Vibration absorber

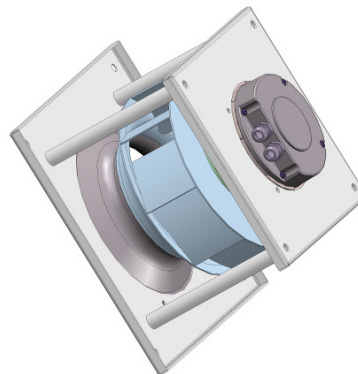

picture: fan GKHM

- Before starting the power supply it is necessary to check if all assembly components are ready for use and to adjust them.
- Check the correct function of the fan when you start it up (air supply, balance, vibration or imbalance).
- Check the gap and the gap cover according to the following drawing:

- ► **Check of the gap and gap coverage between wheel and inlet cone**

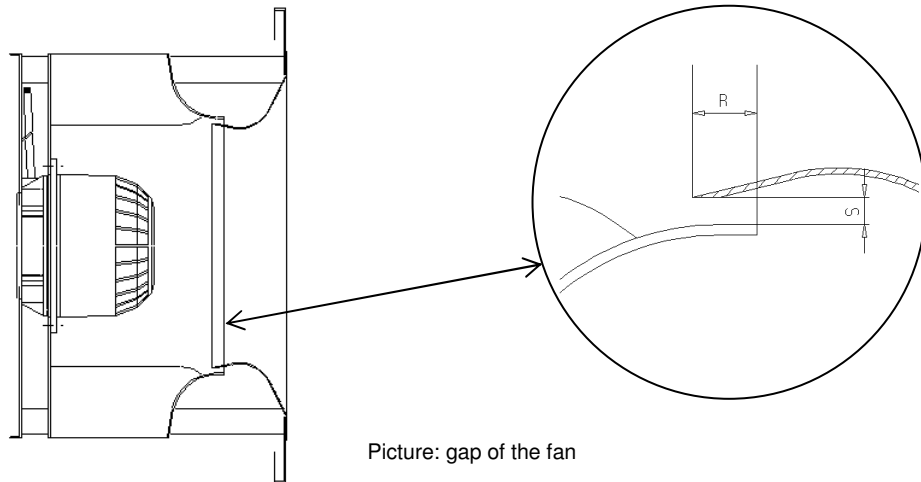

Picture: gap of the fan

- The gap S should be constant on the entire perimeter of the wheel.
- The gap cover R should be about 1 to 2 % of the wheel diameter.

7.4.2 Operation

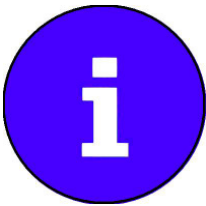

Monitor the fans for correct function during operation. Vibrations, pressure fluctuations or other deviations from the provided parameters should be checked according to the following chapter.

7.4.3 Maintenance and Cleaning

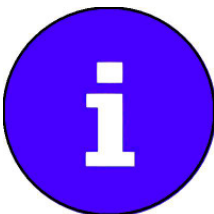

Monitor the unit operation during the first four to twelve weeks regarding the following points:

- Balance, unusual sounds, vibrations
- Fastening of the fan, the motor and the vibration absorbers

The fan as a fast rotating device needs regular monitoring as well as a three-month maintenance interval. In case of deviations from the standard operational conditions (air temperature, increased dust pollution or constant high humidity) or in case of continuous 24-hours-operation a shorter interval must be determined.

Maintenance Fan unit	Every 3 months	If necessary	Hygiene inspection
Check the fan for dirt, mechanical defects, corrosion and proper fastening	X		X
Check the fan gap	X		
Clean the fan unit incl. wheel		X	
Check the wheel for imbalance	X		
Check the quiet running and bearing for sounds	X		

Lubricate or replace the bearing		X	
Check the fan fastening for tightness and mechanical damages	X		
Check the function of the vibration absorber	X		
Check for the existence of the fasteners of the protection units	X		
Check the function of the drainage	X		X
Check the motor for dirt, mechanical defects, corrosion and proper fastening	X		X
Cleaning of the motor housing		X	
Check the power supply	X		
Check the electrical connections for corrosion and proper fastener	X		

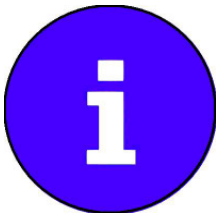

For more thorough cleaning the incoming air fan can be removed. Unlock the four allen-head screws at the chassis rails. Pay attention, that the wiring will first be disconnected.

For more thorough cleaning also the exhaust fan can be unlocked and removed at the four points of the vibration absorber!

7.5 Reverse flow heat exchanger

7.5.1 Setup



Check the correct operation and motion direct of the bypass flap at the reverse flow heat exchanger. Make sure that the bypass flap is in closed position on initiation of the fans and consequently the flap above the plate heat exchanger is opened

Pay attention that the drain pan at the bottom of the reverse flow heat exchanger in the exhaust air is connected to the condensate duct (at the suction side) by a trap. The assembly of a trap has been described in detail under item 5.5.

7.5.2 Operation

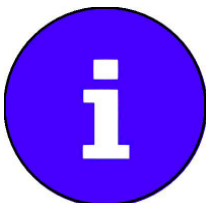

The automatic bypass flap will be controlled by the central unit control using a final control element..

7.5.3 Maintenance and Cleaning



The reverse flow heat exchanger as standard installation element needs little maintenance. For hygienic requirements make regular checks and maintenance work. Furthermore the installed damper servo motor incl. the rods and clamps must regularly be checked and maintained.

Maintenance	every 3 months	If necessary	Hygiene inspection
Inspection of the hygienic condition			X
Check the reverse flow heat exchanger for dirt	X		
Cleaning of the plate set with water (water or steam, the sheet of water should always follow the disc set from top to bottom) Clean the module chamber thoroughly Completely remove the dirty water Lock the maintenance pan		X	
Check the condensate and maintenance pan for dirt	X		
Cleaning of the condensate and maintenance pan		X	
Check the functioning of the trap and water level. Fill in water if necessary.	X		
Check the bypass flap on free movement and repair it if necessary	X		

The water or the used cleaning agent should have a neutral ph-value (6 – 8).



► **Warning: The blades of the reverse flow heat exchanger are very sensitive to contact. Clean and remove them with extreme caution!**

7.6 Panel filter

7.6.1 Setup



- Before installation of the filter all seals should be checked for correct fit. Clean the housing floor.

Pay attention to the directional arrow for the air stream printed on the panel filters

- The units are equipped with one differential pressure sensor for each filter. A signal will appear on the control panel to change the filter. In such case the filter must be changed immediately. More information can be found in the manual of the control system.

7.6.2 Operation

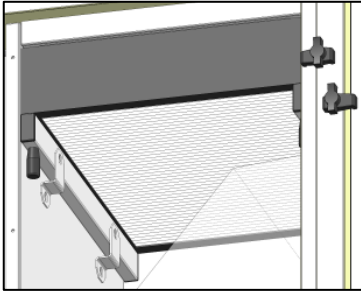

Picture tensioning rail filter:

The panel filters will be fastened with at the assembly frame with a tensioning angle rail. Draw the angle rail to the body in order to change the filter. Pay attention to the correct fit of the filter at the frame after the re-assembly. During the filter change check the seal and replace it if necessary.

7.6.3 Maintenance and Cleaning

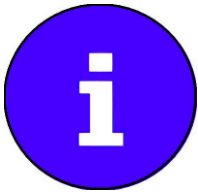

The recommended final resistance for this filter version is 200 PA. Always replace panel filters completely. The filters can be fully incinerated and must be disposed of accordingly. Clean the housing bottom before installing the new filter. Change the panel filter after 12 months of operation or down time at the latest. Note the filter change with name and date at the unit and in the maintenance book.

Maintenance	every 3 months	If necessary	Hygiene inspection
Check for dirt by differential pressure control.	X	X	X
Check the filter element for damages	X		
Replacement of the filter insert		X	
Check the fit for impermeable fit	X	X	X
Check the measure control for the differential pressure	X		X